

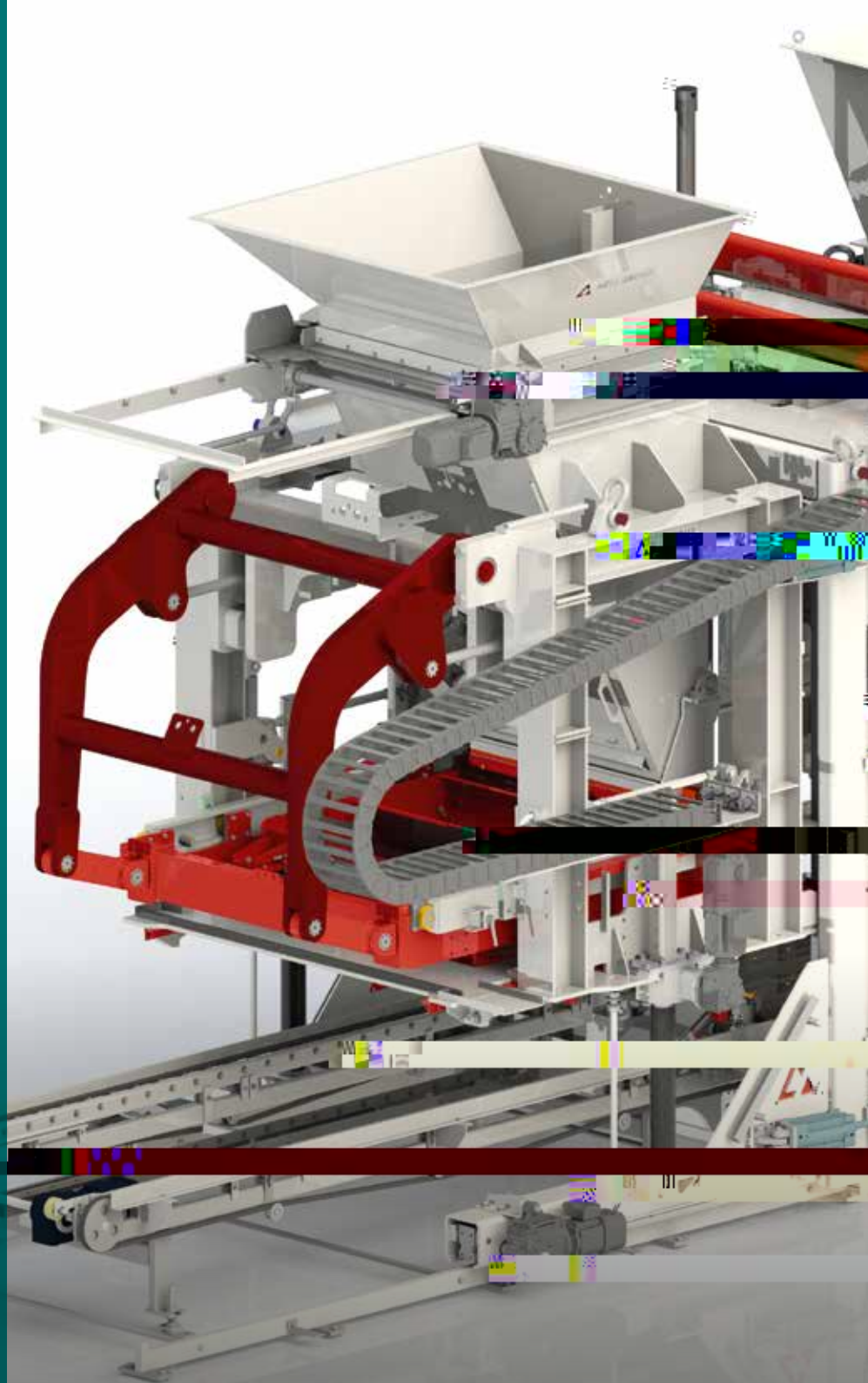

HESS GROUP





B E E

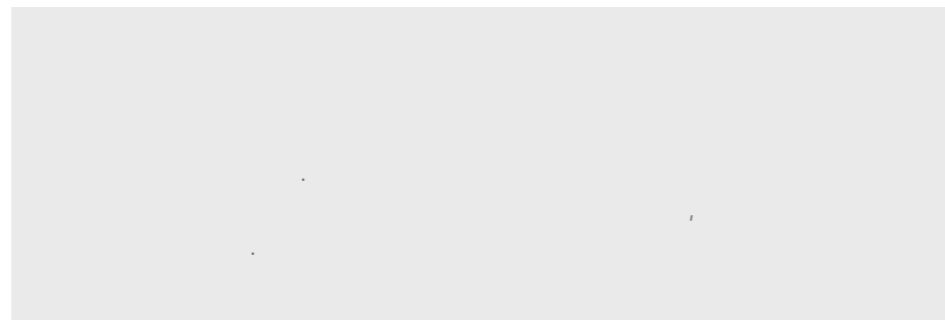
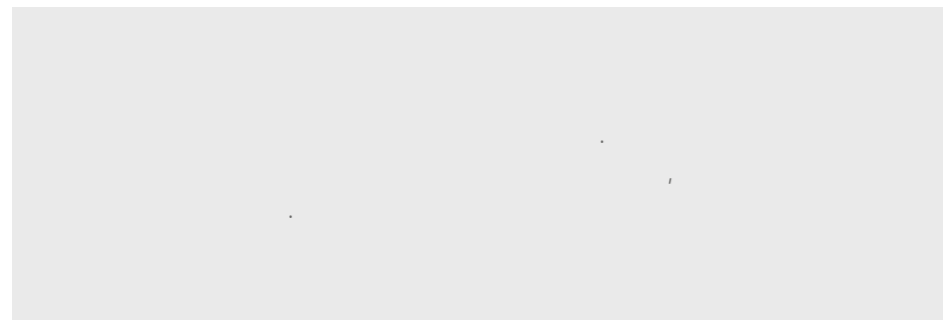
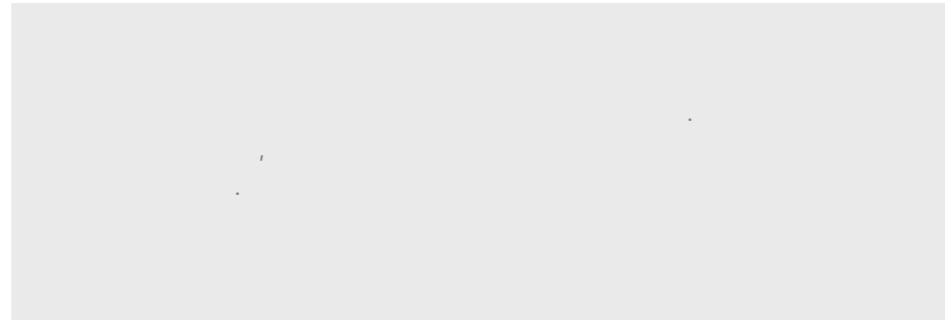
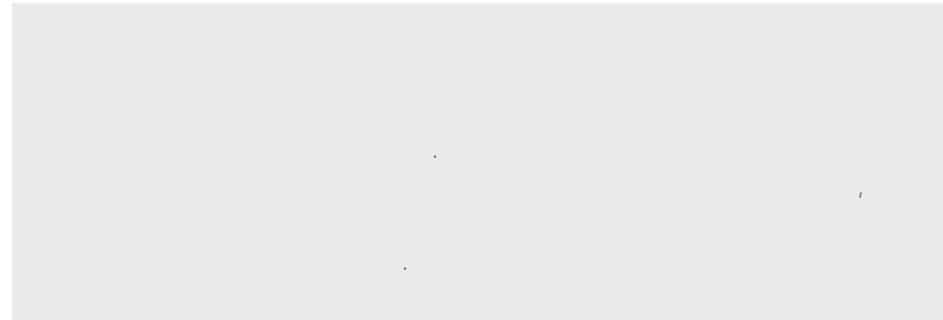

E O T

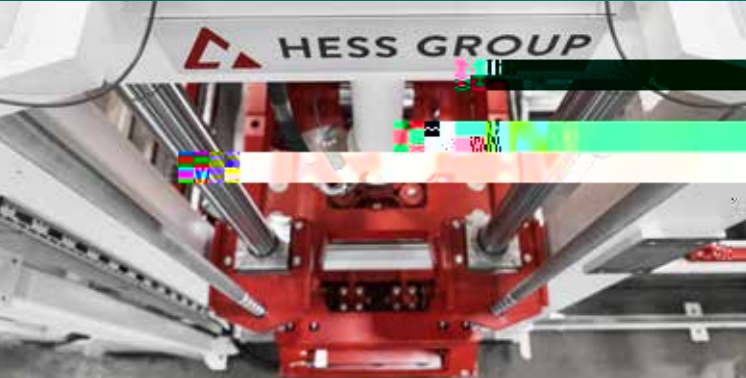

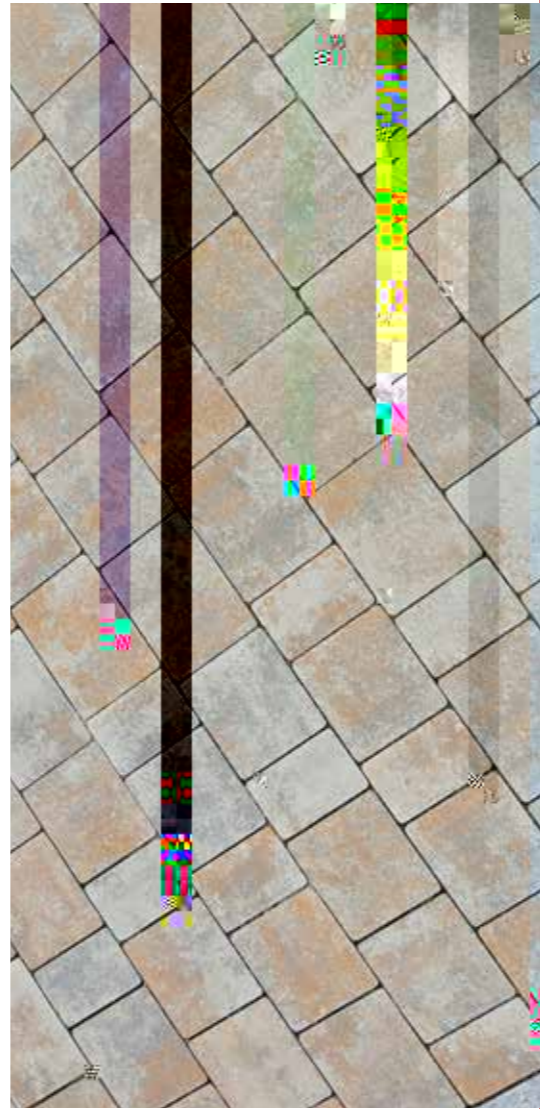
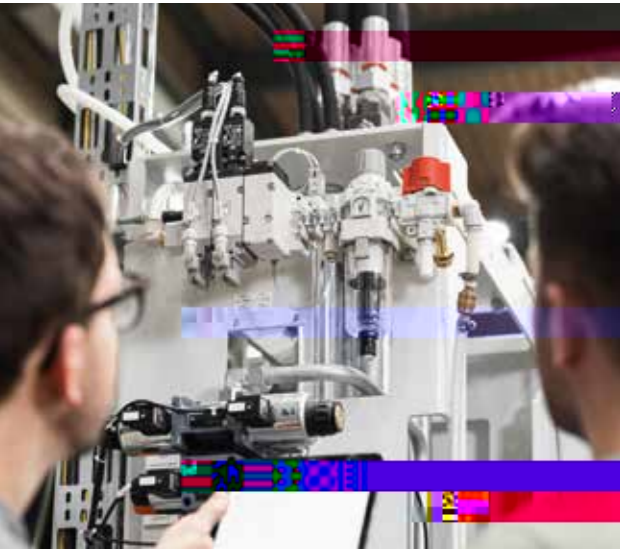

A E

**RH 1450**



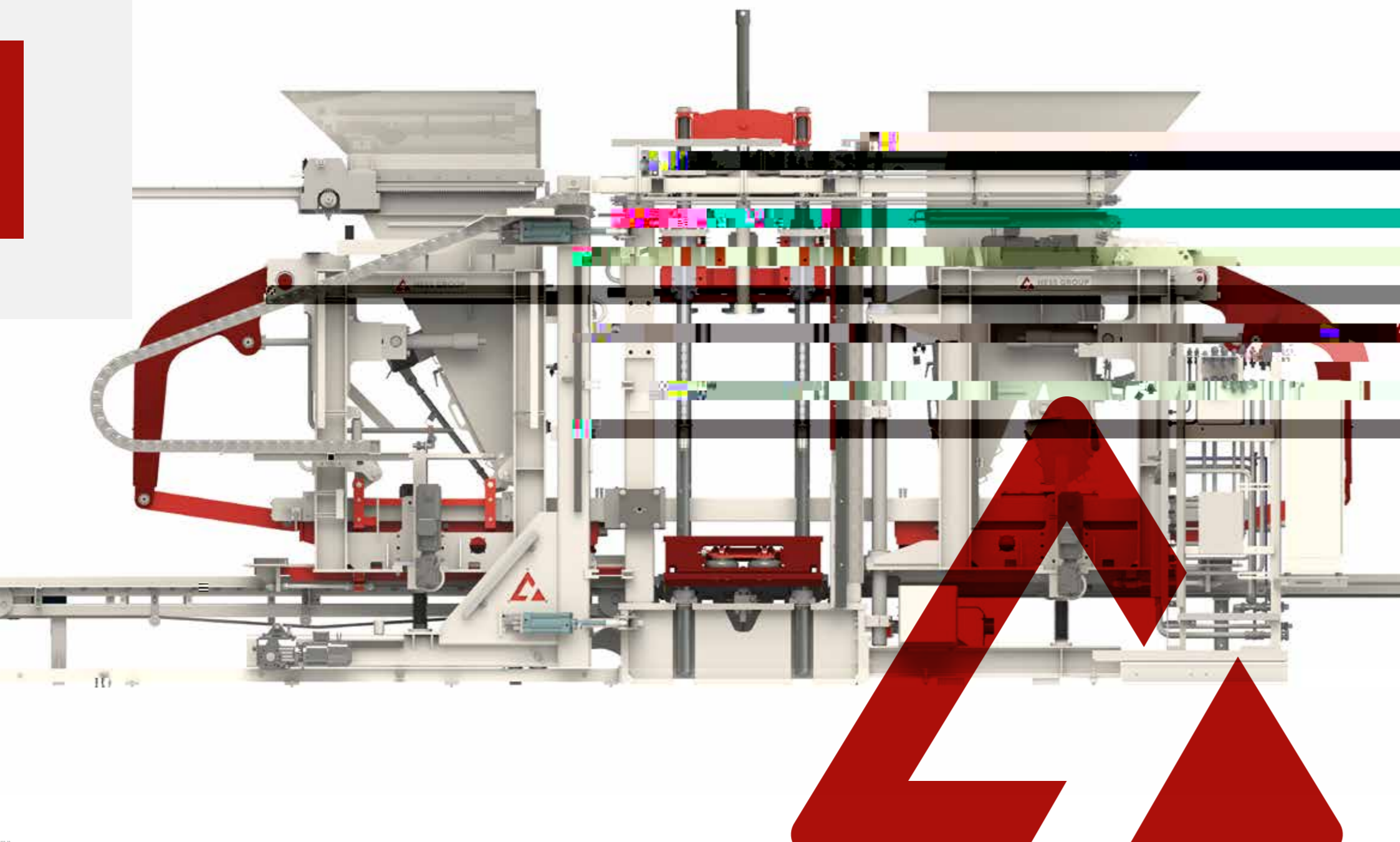

RH 1450

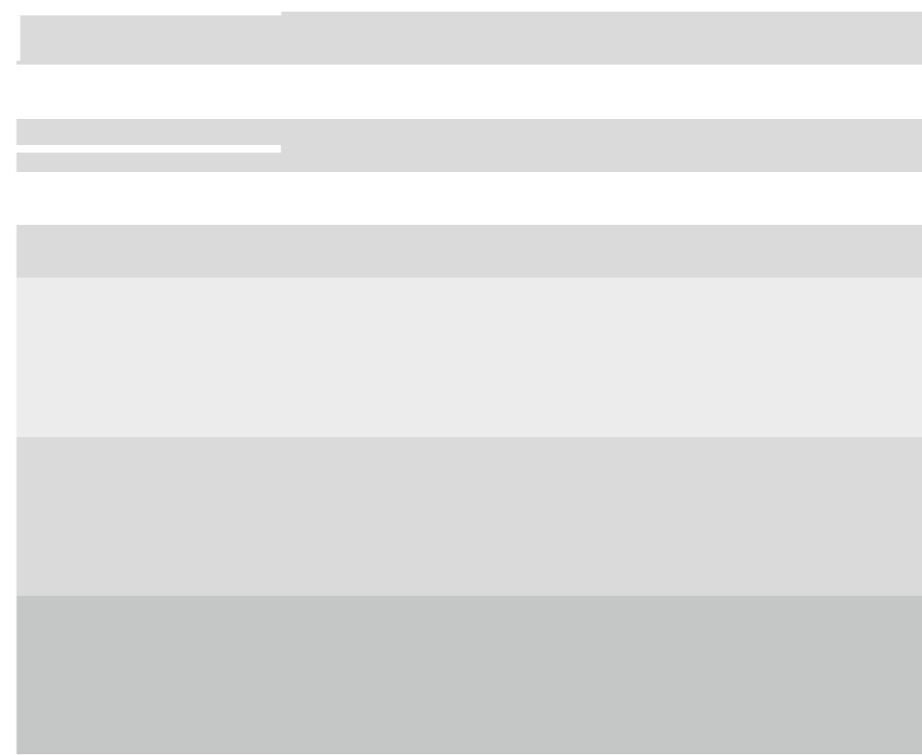

85%



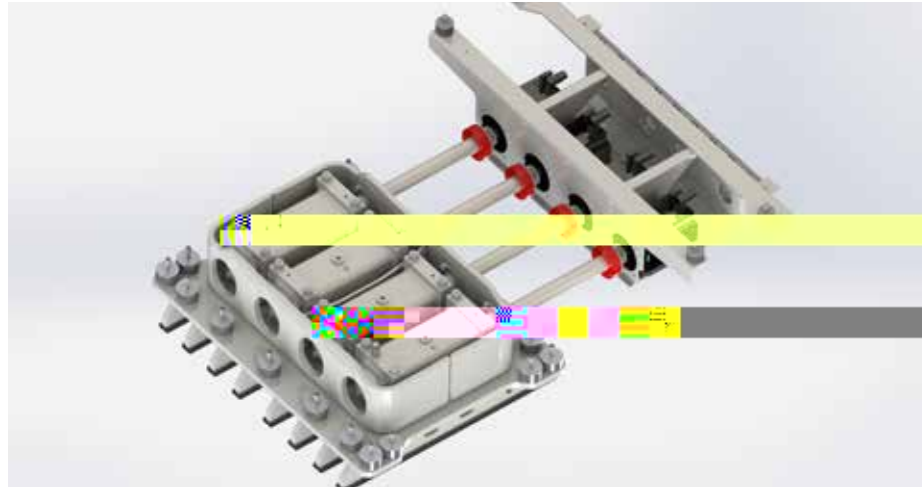
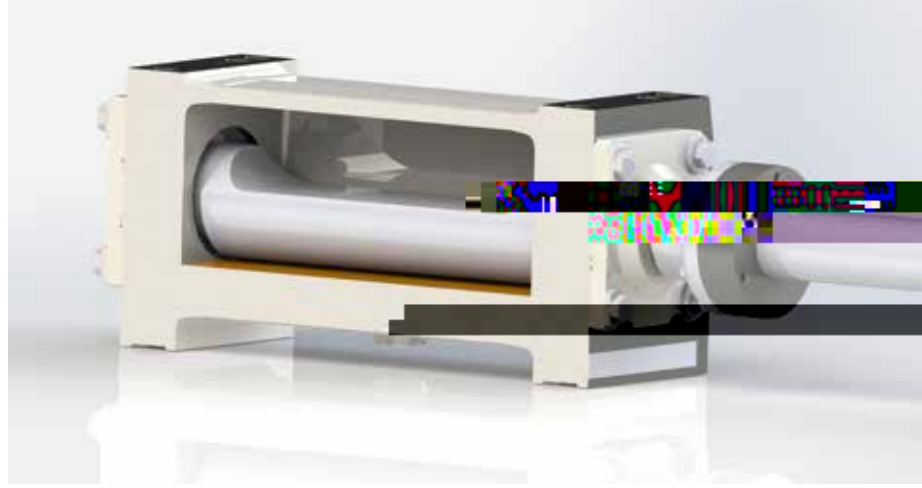

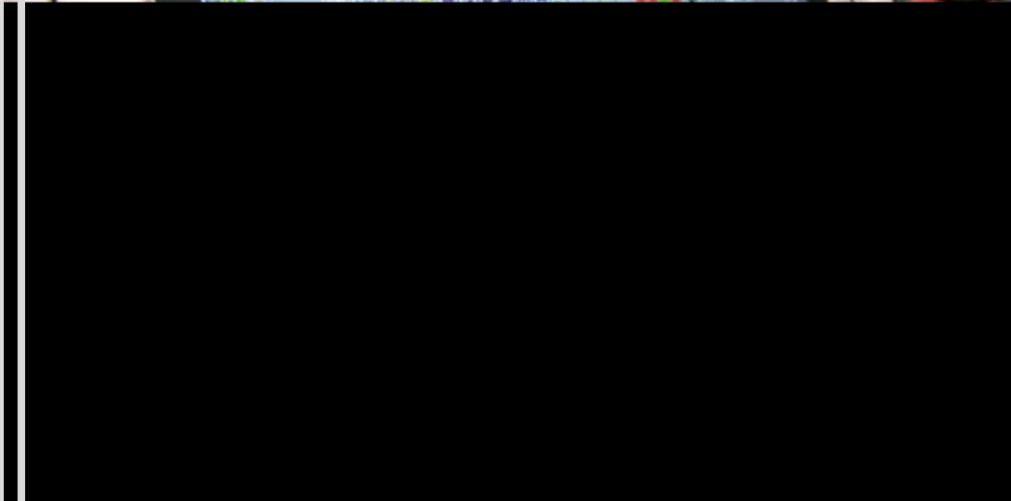
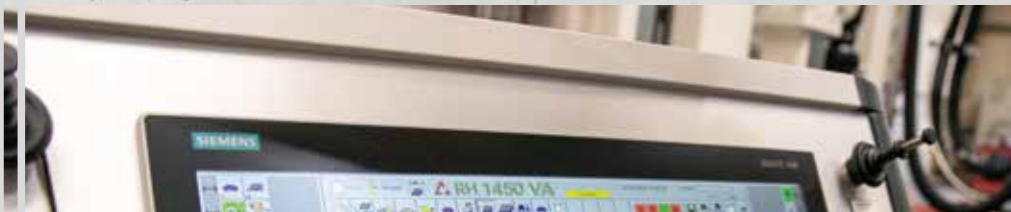

HESS

# Т\_ЕА А ВЛ\_Е\_Е

Hess

HESS

- 
- 
- 
- 

RFID-

	[ ]**	1.200 x 670	1.400 x 700	1.400 x 1.100	1.400 x 1.100	1.400 x 1.300
	[ ]	1.100 x 620	-	1.300 x 1.050	1.300 x 1.050	1.300 x 1.250
	[ ]	25	25	40	25	25
	[ ]	300	300	500	500	500
	VA [ ]	7.700	14.000	38.000	46.000	46.000
10x20x5	[ ]	17	14	12,5	10,5	10
	<sup>2</sup> 8	863	1.258	2.114	2.517	2.644
	[ ]			- 5	4«	
				10x20	14 17	125



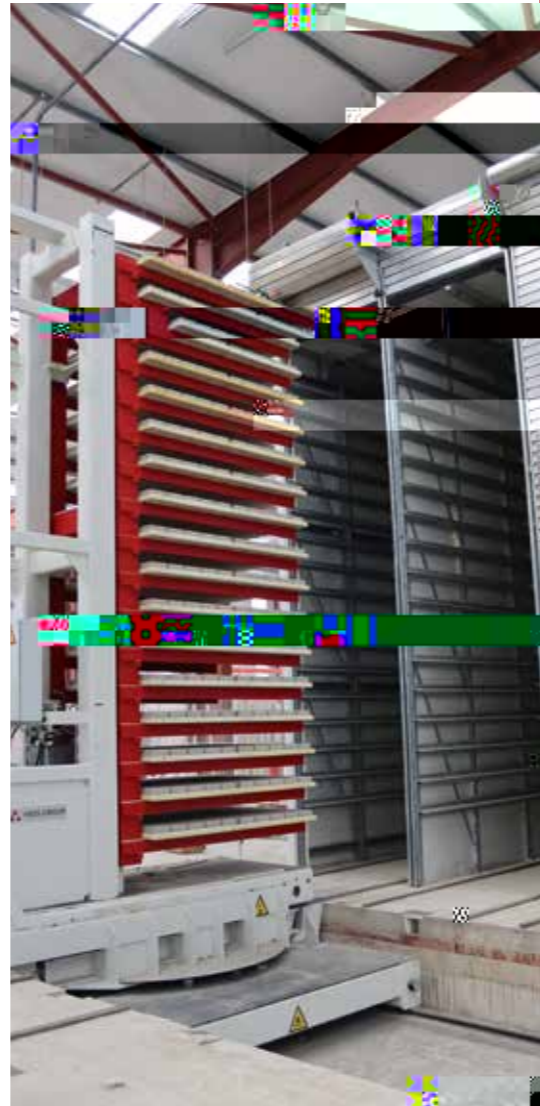
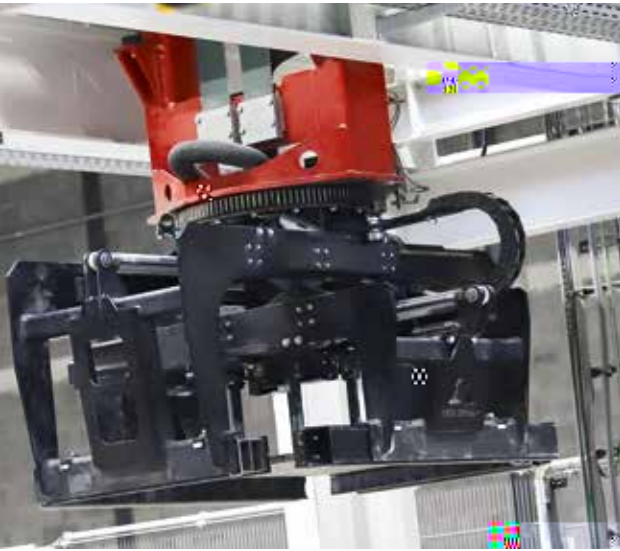

N G  
 E T ЁЬ E  
 TA OВЪ ,  
 TA OT TA  
 T X A  
 B O OAT ЁЬ O E  
 O , O OBA E

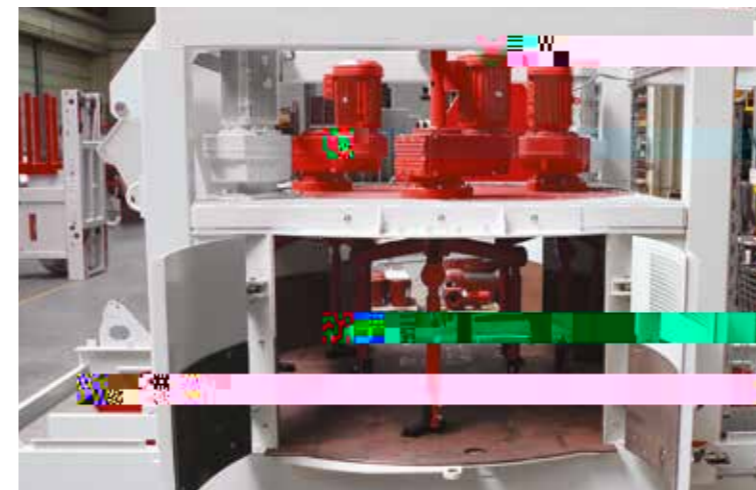

[ ]	500	1.500	2.250	3.375	4.500
[ ]	800	2.400	3.600	5.400	7.200
[ ]	0,333	1	1,5	2,25	3
[ ]	15	22	30	2x 22	3x 22
[ ]	1+1	2	2	3	3
[ ]	7,5	18,5	18,5	22	30

SM

- ( )
- ( )

HESS

Е Т Ё Ь  
ТА ОВ 7 E

Color-Mix.

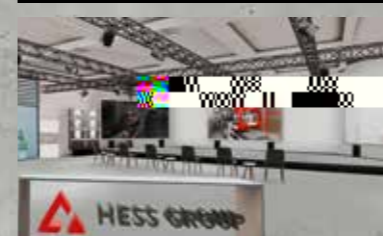
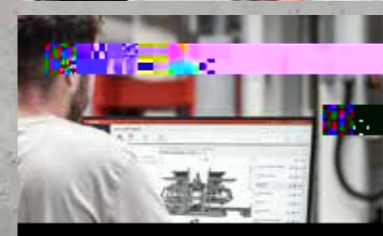
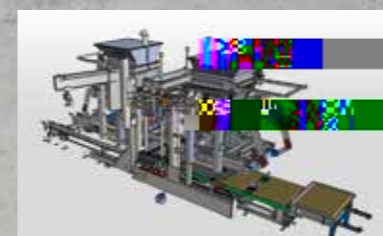



Freier-Grund-Straße 123  
57299 Burbach-Wahlbach,

: +49 2736 4976 0

: info@hessgroup.com

[www.hessgroup.com](http://www.hessgroup.com)